



AirSpeed[®] Turbo

Air Cushion Machine



Operator Manual

Safety and Operation

Revision 1

CONTENTS

- 1 SPECIFICATIONS 1
 - 1.1 Sound Test Declaration..... 1
- 2 OPERATING SAFETY 2
 - 2.1 Safety 2
 - 2.2 Warning Labels 3
- 3 SCOPE AND LIMITS 4
 - 3.1 Introduction..... 4
 - 3.2 Inputs and Outputs 5
 - 3.2.1 Compatible Accessories 5
 - 3.3 Dismantling..... 5
- 4 GENERAL OPERATION 6
 - 4.1 Setting up the Machine 6
 - 4.1.1 Mounting Options 6
 - 4.1.2 Installing Feet and Mounting Hardware 6
 - 4.1.3 Power On 6
 - 4.2 Changing Film 7
 - 4.2.1 Loading Film..... 7
 - 4.2.2 Removing Film 8
 - 4.3 Starting the Machine 8
 - 4.3.1 Initial Startup 8
 - 4.3.2 Running Film 8

- 5 ADVANCED OPERATION..... 9
 - 5.1 Home Screen 9
 - 5.1.1 RFID Recipe Overview..... 9
 - 5.2 Table of Symbols 10
 - 5.3 Fill Mode Adjustments 12
 - 5.4 Air Level and Temperature Adjustments 12
- 6 TROUBLESHOOTING..... 13
 - 6.1 Error Codes 13
 - 6.1.1 Resolving Errors 13
 - 6.2 Clearing Jams..... 14
 - 6.3 Other Items..... 14
 - 6.3.1 Wrinkled Seal..... 14
 - 6.3.2 Jamming at Startup..... 14
 - 6.3.3 Pillow Pops Off Air Tube 14
 - 6.3.4 Flat Pillows 15
 - 6.3.5 Tearing at Seal 15
 - 6.3.6 Perforation Failure 15

Property of the Pregis Corporation

**1650 Lake Cook Road
Suite 400
Deerfield, IL 60015
United States of America**

Authorized CE Representative

**ACC – Services Contact
1877 Kirby Lane
Kyle, Texas 78640
United States of America**

AirSpeed® Turbo

120/230 VAC, 5.0/2.6 A, 60/50 Hz

Weight: 25.4 lbs / 11.5 kg

**EC DECLARATION OF CONFORMITY
EU DECLARATION OF CONFORMITY**

**PREGIS LLC
165 Lake Cook Road
Deerfield, IL 60015
USA**

Placeholder

LANGUAGES OF OPERATION DISCLAIMER

It is *illegal* to operate this machine in an EU member state if this (or any other related) manual is not written in that State's language. If a translated version is needed, contact Pregis to order the manual.

The original version of this manual is in English and denoted "Original Instructions" in the top right corner. All translated versions are denoted "Translation of Original Instructions" in the same location.

1 SPECIFICATIONS

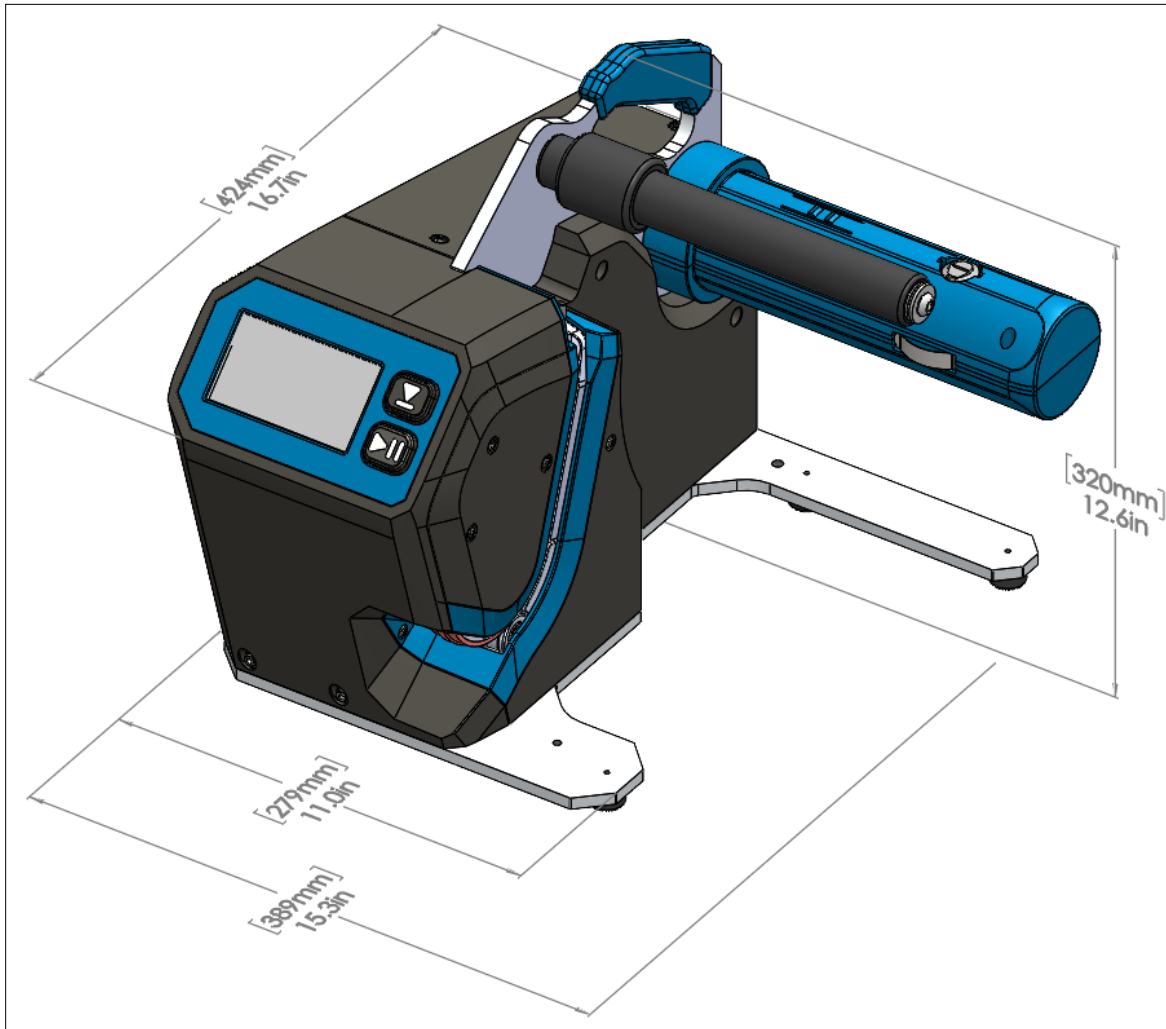

Figure 1. Machine dimensions.

Machine

Weight: 25.4 lbs / 11.5 kg

Overall Size (L x W x H): 16.7 x 15.3 x 12.6 in / 424 x 389 x 320 mm

Power: 120/230 VAC, 5.0/2.6 A, 60/50 Hz

Production Speed: 100 feet per minute / 30.5 meters per minute

1.1 Sound Test Declaration

The equivalent sound pressure level L_{eq} at the operator station is **XX dB(A)**.

2 OPERATING SAFETY

AirSpeed® Turbo

Air Cushion Machine

Operator safety and the safety of others in the work area depend on the operator using common sense, good judgment and reasonable care while operating the machine. The Safety, Operation and Maintenance manual, and warning labels affixed to the machine, provide notification of specific potential hazards.

2.1 Safety

The following instructions are only a guideline and should be considered a supplement to your plant's comprehensive safety program. Your company's policy supersedes these guidelines if at any time the two contradict each other.

1. Read and understand the manual. If after reading the manual you have questions, get answers before working with the machine.
2. Read and understand all the danger, warning, and caution statements in the manual and on the signs attached to the equipment.
3. Never deface or remove factory installed warning decals. If a decal ever becomes lost, damaged, or illegible, report this condition to a supervisor and obtain a replacement decal.
4. Keep the work area clean and uncluttered. Walking surfaces should always be free of packing material and debris to prevent a slipping or tripping hazard.
5. Ensure that all covers, guards, and other safety devices are in place. Never remove a safety device for any reason.
6. Follow the manufacturer's recommended startup procedure.
7. Never leave the equipment unattended while operating. Shut the machine off if you must leave the work area.
8. Keep body parts and clothing away from moving components. Ties, scarves, long hair, and gloves are especially dangerous.
9. Understand what will happen when you operate the various controls.
10. Understand the proper web path and the safe method for threading the web.
11. Learn the safe procedure for clearing the machine of web wraps or jams.
12. Exercise extreme care whenever it is required to inspect or adjust the machine while it is in motion. **NEVER reach into the machine for any reason while it is in motion.**
13. Understand which adjustments are operator adjustments; only trained and qualified service personnel may maintain/clean any electrical and or mechanical part of the machine.
14. Never operate or work around equipment if you are under the influence of alcohol, drugs or medications that can make you less alert or affect your judgment.
15. The machine shall be used in a facility adequately ventilated for air renewal.

2.2 Warning Labels

The Operating Safety section of this manual, the Operator manual, and warning labels affixed to the machine provide notification of specific potential hazards.

Safety signs are used to alert operating and maintenance personnel to potential hazards. The machine manual also calls attention to potential hazards with statements describing the hazard. Warning labels used on the machine are depicted below.

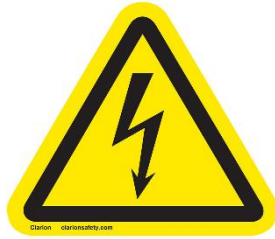

Electric Shock



Hot Surface



Refer to Instruction Manual



Hand Entanglement, Rollers

The meanings of the warning labels and the potential hazards they represent must be clearly understood before attempting to operate or maintain the machine. If, at any time, a warning label on the machine becomes lost, damaged, or illegible, contact Pregis to order replacement signs.

3 SCOPE AND LIMITS

AirSpeed® Turbo Air Cushion Machine

3.1 Introduction

The Pregis AirSpeed® Turbo produces panels of air-filled packing cushions in any quantity, as needed. The ability to create packing cushions on demand saves storage space and reduces packaging material waste.

Supported film rolls have a maximum size of the following:

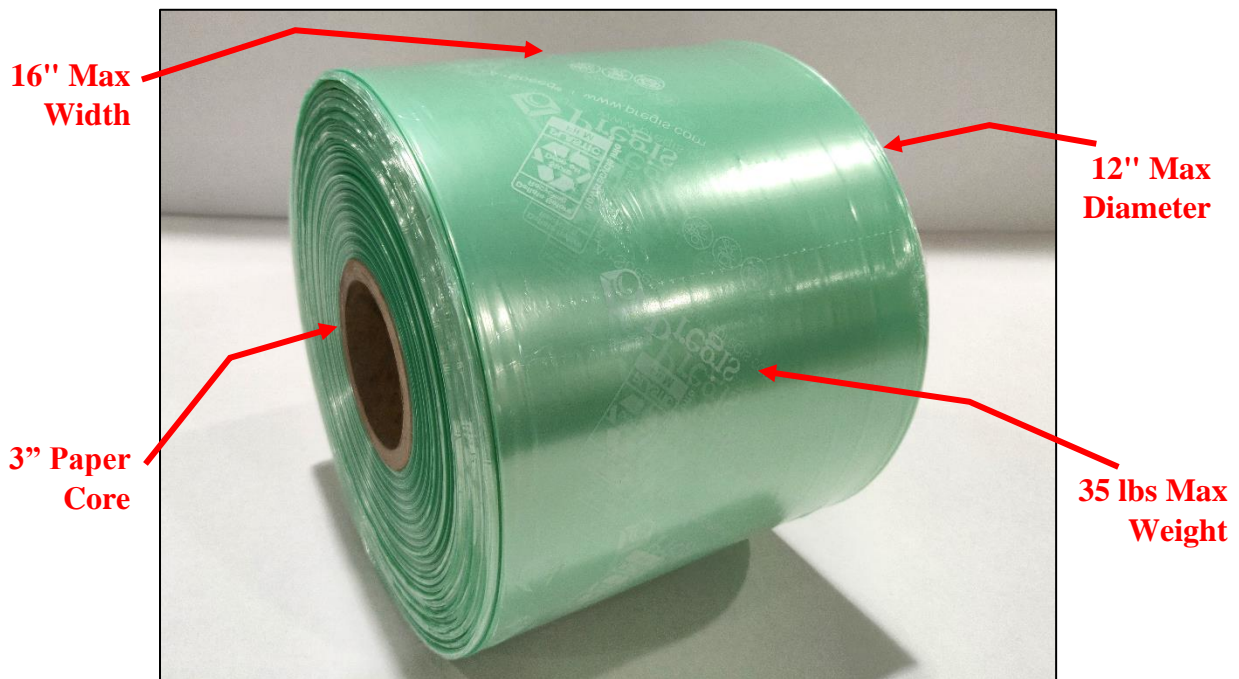

Figure 2. Supported roll dimensions.

Use of the machine for any purpose – other than stated – may cause severe injury to the operator and/or damage to the machine.

3.2 Inputs and Outputs

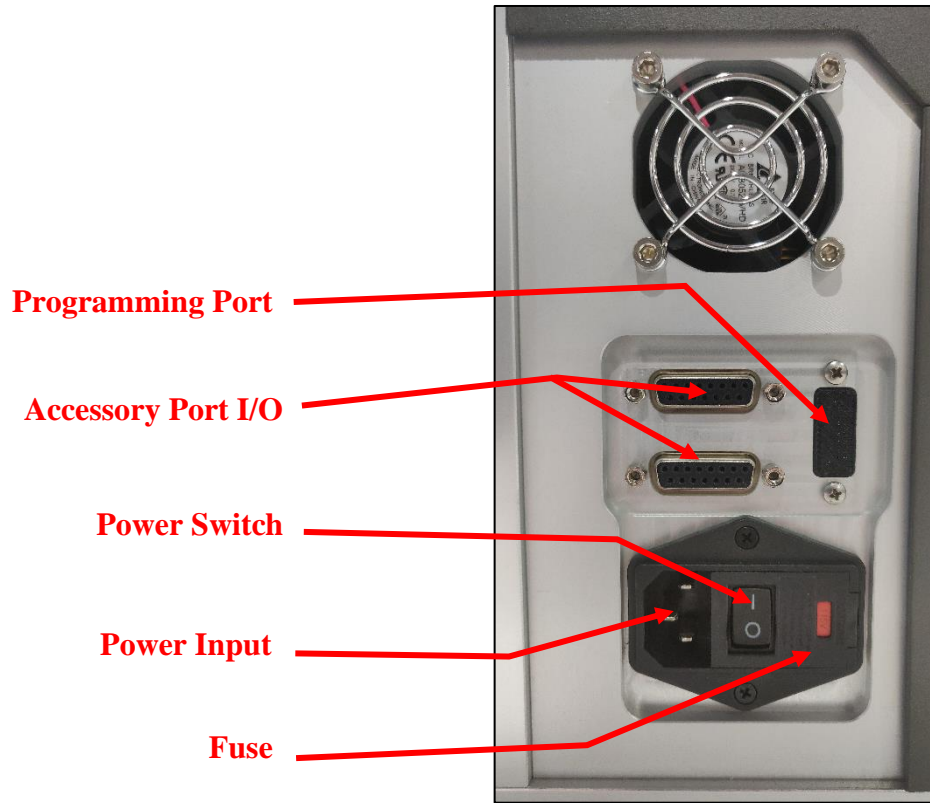

Figure 3. Inputs and Outputs.

3.2.1 Compatible Accessories

For a list of accessories compatible with the AirSpeed® Turbo, see the Pregis Systems Catalog.

3.3 Dismantling



Upon dismantling of this system at the end of its service life, please follow the local recycling laws and regulations in effect at that time.

4 GENERAL OPERATION

4.1 Setting up the Machine

4.1.1 Mounting Options

The machine can be mounted either horizontally, vertically, or on a “C” frame.

Horizontal mounting utilizes a baseplate and a floor stand with casters for ease of movement. Place the machine on the baseplate and stand and secure with (2) M8 x 1.25 x 30mm bolts at the holes labeled BE and (2) M6 x 1.0 x 30mm bolts at the holes labeled D.

Optionally, the machine can be mounted vertically on a frame with an attached bin, called a “C” frame. The “C” frame is mounted on casters for ease of movement.

Vertical mounting also utilizes a baseplate to assist in mounting to a vertical plane. This configuration is ideal for use with overhead delivery systems.

4.1.2 Installing Feet and Mounting Hardware

To install the feet (SAP# 1027857, 1027881) or mounting hardware (SAP# TBD), reference the figure below.

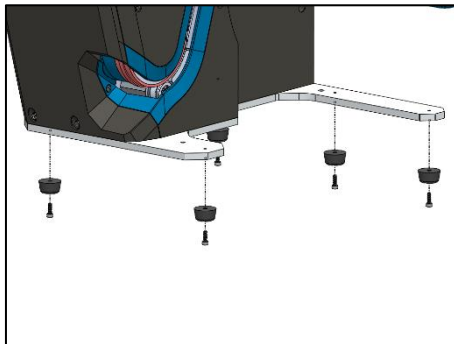

Figure 4. To remove or fasten the five rubber feet, use a 3mm hex wrench. (All five shown.)

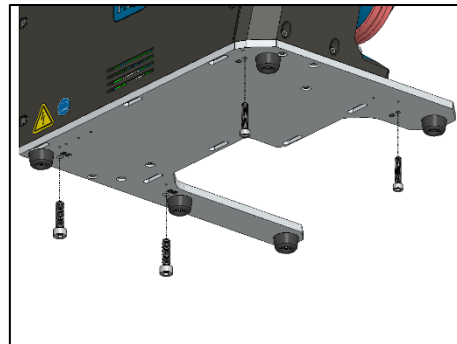

Figure 5. To mount the machine to a stand or frame, use a 6mm and 5mm hex wrench.

Note: If the machine is used without a stand or frame, ensure that the five rubber feet are fastened to the base of the machine.

4.1.3 Power On

Plug the AC power cord into the back of the machine. Insert power cord into a suitable outlet. Power the machine on or off using the **Power Switch** on the rear of the machine. See **Section 3.2**.

DO NOT POWER ON MACHINE UNTIL IT IS SECURED.

4.2 Changing Film

4.2.1 Loading Film

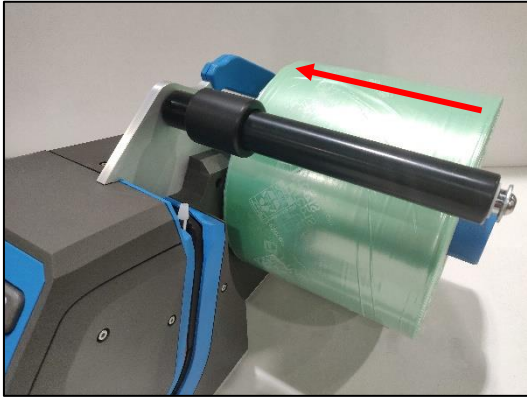

Figure 6. With the air channel first, slide the film roll onto the Spindle.



Figure 7. Firmly press the roll to the end of the Spindle, up against the flange.

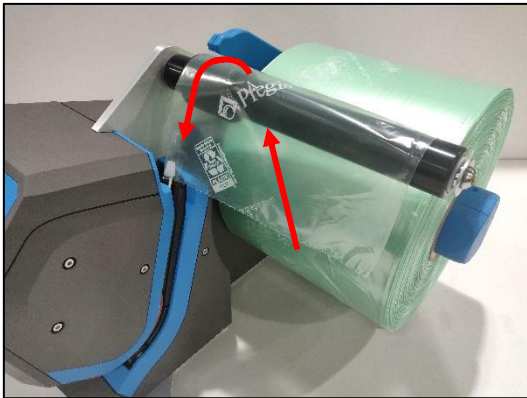

Figure 8. Pull the film off the roll and over the Guide Roller.

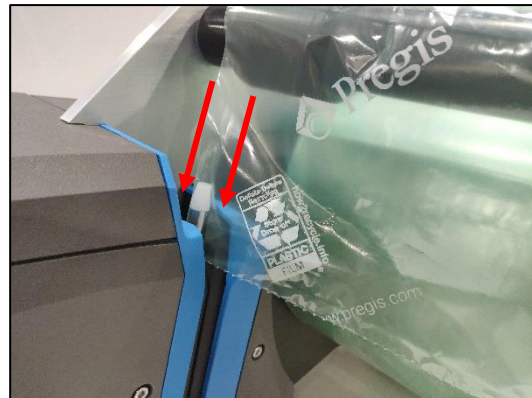

Figure 9. Thread the Air Tube into the air channel.



Figure 10. Pull the film forward to the Backing Wheel (larger, red wheel).

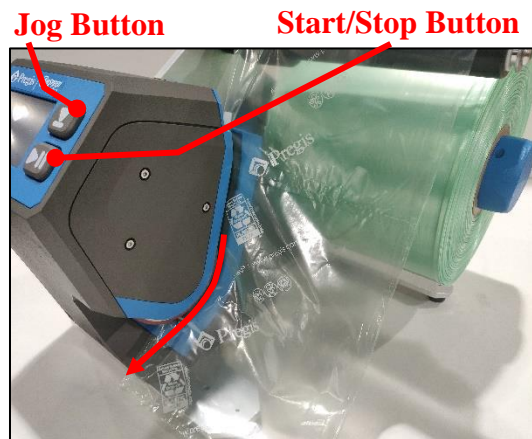

Figure 11. While holding down the Jog button, pull the film past the Nip Roller (lower, black wheel).

4.2.2 Removing Film

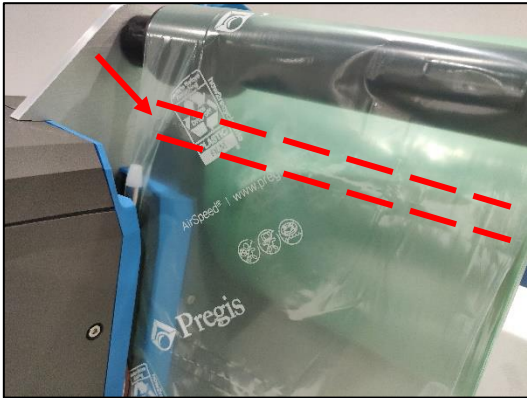

Figure 12. Tear the film along a perforation between the roller and the air channel.

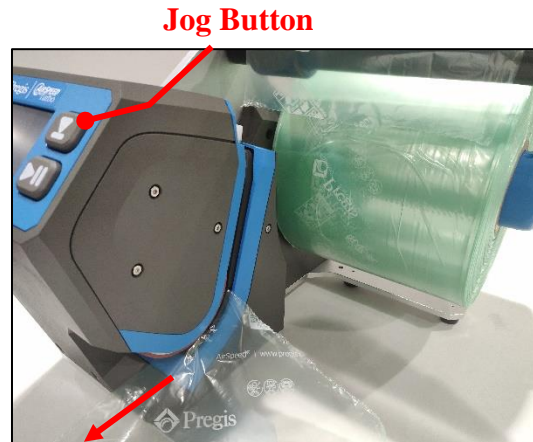

Figure 13. Use the **Jog** button to pass the remainder of the film through the machine.

4.3 Starting the Machine

4.3.1 Initial Startup

Upon startup, the machine will require user interaction to warm up. Once this step is complete, the machine will be ready to run film.



Figure 14. Wake up the machine by pressing the Wake from Sleep Button.

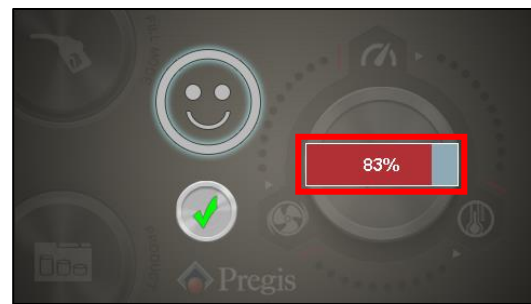

Figure 15. Wait for the heater to warm up. Progress is displayed on the right side of the screen.

4.3.2 Running Film

To run film through the machine, first follow all prior steps outlined in **Section 4**. To start the machine, press the physical or touchscreen Start/Stop button. See **Section 5.2**.

5 ADVANCED OPERATION

5.1 Home Screen

Each item displayed below is described in the **Table of Symbols**, located in **Section 5.2**.











Figure 16. Reference Home Screen.

5.1.1 RFID Recipe Overview

The recipe (preset operating parameters) for each film type is automatically loaded from the RFID tag on the roll. **Air Level** and **Temperature** settings are adjustable within a predefined range. See **Section 5.4**.

5.2 Table of Symbols

Symbol	Name	Description
	Sleep/Wake Symbol	Displayed on startup, this symbol indicates whether the machine is in Sleep Mode . See Section 4.3 .
	Wake from Sleep Button	Use this button to wake the machine from Sleep Mode . See Section 4.3 .
	Progress Bar	Function progress is displayed on the right side of the screen for various processes, including Wake from Sleep .
	Start/Stop Button	Use this button to Start the machine. While the machine is running, this turns into a Stop button able to stop the machine if pressed. See Section 5.1 .
	Start/Stop Button (Physical)	The physical Start button performs similarly to the touchscreen button. It is located near the lower right corner of the front panel. See Figure 11 in Section 4.2 .
	Jog Indicator and Button	The Jog button is used to load film. Hold the touchscreen Start/Stop button for 3 seconds access the Jog feature. Alternatively, use the physical Jog button.
	Jog Button (Physical)	The physical Jog button is used to load film. It is located near the upper right corner of the front panel. See Figure 11 in Section 4.2 .
	Back Button	The Back button allows the user to return to the Home Screen .
	Fill Mode Button	This button brings up the Fill Mode menu. Depending on fill mode, length/time per run can be set by pressing the Run Time/Length button. See Section 5.3 .
	Run Time/Length Buttons	Once a mode is selected in the Fill Mode menu, length/time per run can be set by pressing either indicator. See Figure 18 in Section 5.3 .
	Run Time/Length Indicator	Once Run Time or Length is selected in the Fill Mode menu, the appropriate indicator will display on the Home Screen .

Symbol	Name	Description
	Seal Temperature Indicator and Button	By selecting the Seal Temperature button, one can adjust the sealing temperature. Once set, the Seal Temperature Indicator will blink until the machine is ready.
	Wait Symbol	The Start/Stop button will turn into a Wait symbol while a temperature change is in progress. See Section 5.1 .
	Air Level Button	By selecting the Air Level Button , one can adjust the air level. See Section 5.1 .
	Production Speed Button	By selecting the Production Speed button, an authorized user can adjust the production speed. This setting is not customer adjustable. See Section 5.1 .
	RFID Film Type Indicator	This indicates the detected RFID Film Type and is located to the right of the Fill Mode button. See Section 5.1 .
	Enter/Delete Key	When changing a value via the Keypad , use the Enter Key to save the displayed value. The Delete button can be used to erase numbers as needed.
	Keypad and Level Visualizer	When changing a setting such as Fill Mode , Seal Temperature , or Air Level , use the keypad to change the value. The Level Visualizer will display the range of acceptable values.
	Bin Mode Toggle	If the machine is attached to a bin, this setting will be enabled. This setting is not customer adjustable.
	Bin Mode Indicator	This indicates that Bin Mode is enabled when/if the machine is attached to a bin.
	Bin Empty/Full Indicator	While in Bin Mode , indicators will activate if the bin is empty or full.
	Winder Enabled	This indicates that Winder Mode is enabled when/if the machine is attached to a winder.
	Winder Idle / Threading Indicator	While in Winder Mode , indicators will activate if the winder is idle or threading.

5.3 Fill Mode Adjustments

Pressing the **Fill Mode** button brings up the **Fill Mode Selection** menu.



Figure 17. The Fill Mode Selection menu allows the user to toggle between length and time per run.



Figure 18. Both length and time per run can be adjusted by selecting the Run Time/Length icon.



Figure 19. Length mode allows the user to select set length of pillow whenever the Start button is pressed.



Figure 20. Time mode has a similar function, but run time is determined in minutes and seconds.

After desired value is entered, click the **Enter** key and return to the **Home Screen** using the **Back** button. **Continuous Mode** can be activated by entering zero (“0”) for either setting in **Time** or **Length** modes. In this mode, the machine will run until stopped by the user.

5.4 Air Level and Temperature Adjustments

Pressing the **Air Level** button and **Seal Temperature** button opens the **Blower Setting** and **Seal Drum Setting** menus, respectively.

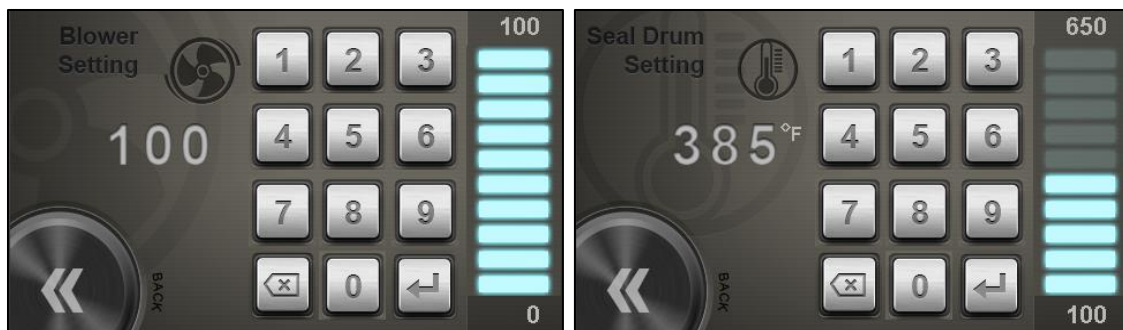

Figure 21. Input the desired value, click the Enter key, return to the Home Screen using the Back button.

6 TROUBLESHOOTING

6.1 Error Codes

Code	Name	Cause	Solution
*136	CM Power Fault <CR> See Manual	AC Common Mode Error detected. Latching Error	Check all AC wiring and components. Power cycle the machine.
250	Film Jam Error / Film NOT Advancing	Roll is out of film	Replace with full roll. See Section 4.2.
		Material not properly threaded onto air tube	Ensure material is properly threaded onto air tube. See Section 4.2.
		Material is jammed	Clear jam if possible. See Section 6.2.
460	RFID Error: No Tag	No RFID tag detected	Rotate roll of material.
			Verify material type.
			Load an alternate roll of material.
462	RFID Error: Invalid Material	RFID tag detected is not for the Turbo Machine	Verify material type.
			Power cycle the machine.
			Load an alternate roll of material.
464	RFID Error: Bad Tag Status	RFID tag detected is not readable	Rotate roll of material.
			Power cycle the machine.
			Load an alternate roll of material.
466	RFID Error: Bad Checksum	RFID tag detected has a bad checksum	Rotate roll of material.
			Power cycle the machine.
			Load an alternate roll of material.
468	RFID Error: No Recipe	RFID tag detected has no recipe on the Turbo Machine	Load an alternate roll of material.
			Load latest recipe set.
470	RFID Tag Error: Invalid Tag	Invalid number of Blocks on RFID Tag, may be corrupted	Rotate roll of material.
			Power cycle the machine.
			Load an alternate roll of material.

Note: **Error 136 may present during power surges or lightning events. This is expected behavior. Power cycle the machine to restore operation in this event.*

6.1.1 Resolving Errors

Errors displayed that are not described above should be resolved by attempting the following steps. (For **Error 136** start with item 2.)

1. Clear the error. Remove the machine from sleep or start a cycle.
2. Locate the power switch on the rear of the machine and restart the machine. Start a cycle after allowing the machine to heat.
3. Power off the machine and remove the power cord for 30 seconds. Plug back in the power cord and repower the machine. Start a cycle after allowing the machine to heat.
4. If a problem persists, call Technical Services at 886-904-6979.

6.2 Clearing Jams

In the event the machine jams, first break the web. Then, attempt to advance the material through the machine with the **Jog** button. If the jam persists, power off the machine. Attempt to remove the jammed material with your hands by pulling the film backwards, opposite to the feed direction. Do not remove the safety covers. Do not attempt to cut away material.

If the jam persists, call Technical Services.

6.3 Other Items

Depending on machine settings, material production may be less than optimal. Refer to the following to rectify the most common issues.

6.3.1 Wrinkled Seal

If the material leaves the machine with a large wrinkle in the seal – specifically in the cross-machine direction – ensure the roll of material is properly seated on the spindle. The inner core should be seated against the flange on the spindle. Decreasing machine temperature/fill may also remedy this issue. See **Figure 6** in **Section 4.2**.

If the problem persists, call Technical Services.

6.3.2 Jamming at Startup

When loading material through the machine, ensure that the film is jogged all the way through. See **Section 4.2.1**.

If the problem persists, call Technical Services.

6.3.3 Pillow Pops Off Air Tube

In the event a pillow comes off the air tube before being sealed, gets punctured by the air tube, or gets lodged and breaks a perforation, ensure the roll of material is properly seated on the Spindle. The inner core should be seated against the flange on the spindle. Decreasing machine fill may also remedy this issue. See **Figure 6** in **Section 4.2**.

If the problem persists, call Technical Services.

6.3.4 Flat Pillows

If pillows exit the machine underinflated, first increase the inflation setting. Optionally, increase the sealer temperature. Ensure the film's air channel is correctly threaded onto the air tube. Ensure the roll of material is seated against the flange on the spindle. See **Section 4.2**.

If the problem persists, call Technical Services.

6.3.5 Tearing at Seal

If the sealer is too hot, the sealer may burn through the material and air retention may be low. Decrease the sealer temperature.

See **Section 5.4**.

If the problem persists, call Technical Services.

6.3.6 Perforation Failure

If the perforation breaks consistently, check to ensure the film is not rubbing on any object as it leaves the roll. Ensure the roll is properly seated. See **Figure 6** in **Section 4.2**.

If the problem persists, call Technical Services.